

v1.0f last revised 2003/06/13

Sebastian Tannert*
 Andreas Tille†

March 21, 2006

Abstract

The package CIRC is a tool for typesetting circuit diagrams and block schematics. It defines several electrical symbols such as resistors, capacitors, transistors etc. These symbols can be connected with wires in a very easy way.

To use CIRC you only need METAFONT and L^AT_EX 2 ϵ . You do not need PostScript or any drawing tool. You can expand CIRC easily with your own symbols, written in METAFONT.

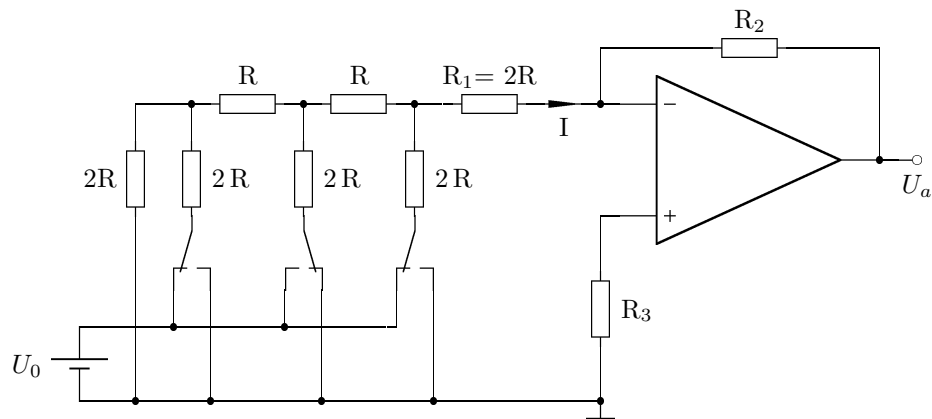

*macro code

†documentation, optics

Contents

1	Introduction	2
2	Installation	3
3	System requirements	4
4	Changes	4
5	Usage	4
5.1	Preamble	4
5.2	Starting a circuit diagram	4
5.3	Drawing symbols	5
5.4	Referencing symbols and pins	6
5.5	Connecting symbols	6
5.6	Positioning commands	7
5.7	Justify commands	8
5.8	Text commands	8
5.9	Example	9
6	Optics	11
7	Some hints for CIRC programmers	12
8	Future plans	13
9	Contacting the authors	13
10	Appendix	14

1 Introduction

In several sciences circuit diagrams are necessary in publications. Perhaps there are some PostScript tools for typesetting them or a drawing program has to be used. With CIRC it is now possible to typeset circuit diagrams using \TeX commands. The commands describe the logical structure of the wiring scheme and \TeX builds the connections according to this structure.

CIRC defines several electrical symbols such as resistors, capacitors, transistors etc. These symbols can be connected with wires in a very easy way.

To use CIRC you only need METAFONT and $\text{\LaTeX} 2_{\epsilon}$. You do not need PostScript or any drawing tool. You can expand CIRC with your own symbols, written in METAFONT.

CIRC has been implemented as a turtle system. That means, there is a current position from where the symbols and wires are drawn. It is possible to choose the drawing direction and drawing position.

CIRC consists of commands in order to
draw symbols and wires into the scheme,
justify symbols within the scheme,
link symbols with wires,
position symbols absolutely or relatively.

2 Installation

Run `circ.ins` through \LaTeX . You will get a couple of `*.mf` files. Use METAFONT to create `*.pk` fonts from all these files. These steps depend on your installation. For example, type:

```
mf \mode=localfont; input ciwidko.mf
gftopk ciwidko.300
```

Do this with all the `*.mf` sources. Copy the resulting `*.tfm` and `*.pk` files into appropriate directories.

Copy the `*.sty`, `*.def` files, obtained from `circ.ins` into appropriate directories in your `TEXINPUT` path.

Read the documentation carefully.

Enjoy CIRC.

We added a Makefile which is tested only under Debian\GNU Linux (running `teTeX`). We would like to get comments whether it works under other environments. **Use it at your own risk!**. Type

```
make
```

to get all files used by CIRC. Before you type

```
make install
```

you should check the correct `PATH` names in the Makefile. (Make sure you run `make install` as root.) This will do the the following:

1. Delete old CIRC files in `TEXINPUT` and `MFINPUT`.
2. Move the new `TEXINPUT` and `MFINPUT` to the appropriate directories
3. Check the `special.map` file in the `Fontname` directory whether there are CIRC related entries and create them if failed. (This will ensure that CIRC fonts will be copied into reasonable directories when using `MakeTeXPK` or `MakeTeXTFM`.)
4. Delete old PK and TFM files from CIRC. (Using old TFM or PK files is one of the "Top ten reasons" why failing CIRC.)

To get the documentation type

```
make doc
```

(generally this is a good idea to create the needed fonts on the fly).

Once more: Please report any bug concerning this Makefile, because this is the first test and not reliable at all.

3 System requirements

CIRC requires L^AT_EX 2_ε and METAFONT.

4 Changes

Unfortunately a change of the parameters for symbol drawing commands had to be made. But now the rules are more consistent and easier to remember. Please have a look at section 5.3. Some new symbols were added and the font selection was modified to work together with the slides class. The appendix has a new design to be clearly arranged. Font names have changed too.

The `\<` command is obsolete now and should NOT used anymore. A new `_` command was defined, see section 5.6.

5 Usage

5.1 Preamble

CIRC is divided into several parts. To use a part put the suitable option in the `\usepackage` command. All parts are included in the following example:

```
\usepackage[basic,box,gate,oldgate,ic,optics,physics]{circ}
```

The parts contain:

- `basic`: a lot of symbols such as resistors, capacitors, switches, diodes, transistors, etc.,
- `box`: blackbox, oscilloscope, generator and amplifier,
- `gate`: several logical circuits,
- `oldgate`: old style logical gates,
- `ic`: integrated circuits (flip flops, etc.) and
- `optics`: the optical stuff with lenses, mirrors, etc. (see section 6),
- `physics`: some mechanics stuff.

A complete list of available symbols is given in the appendix.

5.2 Starting a circuit diagram

It is recommended to draw a sketch with pen and paper before using CIRC.

Every circuit diagram is enclosed in the `circuit` environment

```
\begin{circuit}size
```

where *size* is an integer between 0 and 4 giving the size of symbols and describing text. A size of 4 is useful for overhead foils.

All CIRC macros and the necessary parameters are separated by spaces (`\`). For a clearly arranged CIRC diagram it is advisable to put every command in a separate line (a linebreak is interpreted as a blank as it is used in `TEX`).

5.3 Drawing symbols

The table in the appendix contains a complete list of all CIRC symbols available and corresponding drawing commands. The syntax of drawing commands is:

```
\symbolname number_□ inscription_□ [specification_parameter]_□ direction
```

or for more complex symbols:

```
\symbolname number_□ [further_parameters]
```

Note that you can leave out the blank between the symbol-command and the following *number* parameter. This parameter has to be unique in one drawing and is necessary for correct referring (see `\atpin` in section 5.6).

The symbols can be classified into a lot of different symmetries which are summarized in the appendix. There you will find more detailed information about the parameters you have to use. Generally the drawing direction of the symbol is given with the *direction* parameter which is `l` (left), `r` (right), `u` (up) or `d` (down). If there exist 2 different alignments of a symbol for one direction (e.g. if the LED-arrows show up or down) the second alignment is chosen by capitalization of the *direction* parameter (`L`, `R`, `U` or `D`).

Symbols having two dissimilar or more connections may need a further *specification* parameter in front of the *direction* parameter. This *specification* parameter marks the pin that should be on the current drawing position (see variable resistor and several transistors).

In the appendix `text` was used for the *inscription* and the necessary *number* was set to `n`. Note the position at the symbol where the inscription is set. The inscription can be suppressed by the `\nv` command in front of the symbol-command.

By default every CIRC symbol is marked by a label. This label consists of an abbreviation of the symbol indexed by the *number*. To suppress this labeling use `\nl` in front of the symbol-command.

Another command affecting the inscription of a symbol is `\cc`. It is also used in front of a symbol-command and causes the change of label-position and inscription-position. By default the inscription is typeset left or over the symbol while the labeling is done right or under the symbol depending on the vertical or horizontal orientation of the symbol.

Some symbols need *further_parameters*. The usage is selfdocumenting in the appendix table.

Junctions can be made by the `\.` command (`\junction`)¹. The syntax is:

```
\. number
```

Every junction needs a *number* argument for further referencing.

¹Commands within parenthesis are synonyms for the last introduced command.

5.4 Referencing symbols and pins

Some commands use reference parameters to mark symbols or connections of symbols drawn before.

The *symbol_reference* parameters consist of two parts:

symbolname *number*

The *pin_reference* parameters consist of three parts:

symbolname *number* pinname

These three parts form the *reference* parameter.

See the appendix for the pinnames, they are drawn nearby the pins. If the symbol has no pre-given ones the standard names **l** for the left connection, **r** for the right, **t** for the top and **b** for the bottom one will be chosen.

Note that there is no blank between the parts!

For example, to refer to the left connection of the resistor with the *number* 1 the *pin_reference* parameter would be

R1l

or to refer to the whole symbol the *symbol_reference* is

R1 .

At least it is possible to set markers which work like pin references.

$\backslash P$ *number*

sets a marker which can be referred to by *Pnumber*.

5.5 Connecting symbols

Simple connections between the symbols can be made with the $\backslash-$ command, which is an abbreviation of the $\backslash\text{wire}$ command (see appendix). The syntax is

$\backslash-$ *length* $_direction$.

The parameter *length* is an integer giving the number of lengthsteps. In CIRC wires are build as a queue of characters 2.5mm each. Thus the length of wire is measured in multiples of this length.

The parameter *direction* determines the direction. Valid values are **l** for left, **r** for right, **u** for up and **d** for down. For instance, a wire is drawn to the left with a length of 1 cm (4 units) by typing

$\backslash-$ 4**l**

There are some other line types to connect symbols. The command

$\backslash\text{dashed}$ *length* $_direction$

draws a dashed line. It is written as the $\backslash-$ command. With

`\bundle_text_length_direction`
`\wwire_text_length_direction`

a bundle of wire could be drawn or a pair of wire, respectively. You can use `\=` as an abbreviation of `\wwire`. The *text* may contain any comments.

To connect the drawing position horizontally or vertically with a certain pin of a symbol by using a reference, the useful commands `\htopin` and `\vtopin` exist. The syntax is:

`\htopin_pin_reference`
`\vtopin_pin_reference`

Provided that the resistor `R1` defined before by a `\R` command, the command

`\vtopin_R1l`

draws a vertical wire up to this height, where the resistor numbered with 1 (`R1`) is situated. `\htopin` does the same but horizontally.

The connection will be done by default with the `\wire` command. To change the type of the connection use the `\by` command. The syntax is:

`\by{command}`

where *command* can be one of the following: `\wire` (`\-`), `\dashed`, `\bundle_text`, `\wwire_text` or `\oa` (which is declared in the optics part, see section 6).

For example, the command

`\by{\dashed}`

changes the drawing style from `\[hv]topin` to a dashed lines. Do not forget to switch back to wires using

`\by{\wire}`

to end the dashed lines.

Note that it is usually necessary to combine the `htopin`- and `vtopin` commands, because these commands draw *only* horizontally or vertically to the x- or the y-coordinates of the given pin.

5.6 Positioning commands

Positioning commands are used to change the current drawing position.

The direct positioning command `\at` (`\from`) sets the drawing position to an absolute coordinate.

`\at{x}_\{y}_\`

sets the drawing position to the point (x,y) in the coordinate system, where x and y are integers counting the number of arbitrary units (2.5 mm). CIRC starts drawing at $(0,0)$.

It is recommended to avoid the absolute positioning of symbols, because it tends to destroy the logical structure of the circuit diagram.

The drawing position can be changed in relation to the current position with the indirect positioning command `\moverel` (`\shift`).

```
\moverel{x}{y}
```

moves the drawing position x units to the right and y units upwards.

The command `\atpin` (`\frompin`) sets the drawing position to a reference pin.

```
\atpin{pin_reference}
```

allows further drawing starting from the reference pin. For example,

```
\atpin C2r
```

sets the drawing position to the right pin of the capacitor numbered 2.

In a lot of cases a command like `\-` is useful, but it should not draw the line. `_` satisfy this need. As you know from `\-` a *length* and a *direction* must be specified.

5.7 Justify commands

The command `\hcenterto` forces horizontal centering according to a symbol referred to. The command `\vcenterto` does the same but vertically. The command `\centerto` centers the following symbol according to the reference symbol horizontally or vertically depending on the drawing direction of the symbol being drawn.

The syntax is:

```
\hcenterto{symbol_reference}
\vcenterto{symbol_reference}
\centerto{symbol_reference}
```

For example,

```
\hcenterto L4
```

would force horizontal centering according to the coil numbered 4.

5.8 Text commands

The command

```
\put{text}
```

puts *text* at the current drawing position. It can be used in the same way as the `\put` command of the `LATEXpicture` environment, but the coordinates have to be omitted (because they are given by the current drawing position).

To comment something the commands

```
\Utext{text}{from_pin_reference1}{to_pin_reference2}
\centertext{text}{from_pin_reference1}{to_pin_reference2}
```

can be used. `\centertext` prints *text* centered between *pin_reference1* and *pin_reference2*. `\Utext` additionally draws an arrow from *pin_reference1* to

pin_reference2. Note that the reference pins must have the same x- or y-coordinate.

To write overlapping information like the T_EX commands `\rlap` and `\llap` the following commands are used:

```
\blap{text}
\tlap{text}
```

They put *text* which overlap to the bottom or the top, respectively.

5.9 Example

A simple example is the diagram showing a circuit which is used for measuring the amplification of current by a transistor.

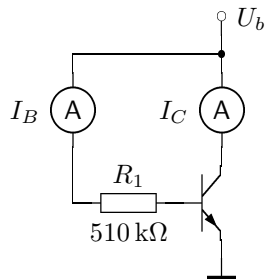

How to cope with such sketches?

First of all, it is necessary to decide, which symbol should be the first one. The transistor seems to be a good choice to begin with in this special case. The command `\npn` produces a npn-transistor (see appendix); so the first line is

```
\npn1 ? B 1
```

which names the transistor `npn1` for further reference. Instead of `{?}` any text describing the specific transistor may be written. (Unfortunately this doesn't work today. See future plans.) The third parameter `B` means, that the base of the transistor should be on the current drawing position. Further more `C` for collector or `E` for the emitter contact would be possible. The last parameter gives the direction, in this case the base contact points to the left (`1`).

Use

```
\frompin npn1C
```

to continue drawing from the collector, and type

```
\- 1 u
```

to draw the needed wire upwards to connect the amperemeter to measure I_C which is created by the command

```
\n1\A1  $\{I_C\}$  u
```

The command `\nl` in front of the amperemeter avoids the default inscription of " I_1 " because this would not make any sense in this case. Instead, the labeling is I_C . The last parameter `u` marks the direction (`\up`).

To draw the resistor connected with the base of the transistor the proceeding is the same: use

```
\atpin npn1B to set drawing position (different from the current position),
\ - 1 1 to draw a piece of wire to the left and
\R1 {510\kohm} 1 for the resistor itself.
```

A further horizontal piece of wire connects the resistor with the second amperemeter: `\ - 1 1 .`

The second amperemeter, measuring the current of the base (I_B), would look nice at if drawn the same height as the first one, measuring (I_C). Measuring the length of wire needed to match the same height would be difficult and a change of the diagram would cause further changes in order to maintain the desired position. Therefore it is advisable to use

```
\centerto A1 \nl\A2 {$I_B$} u
```

which leads to the intended centering automatically. Because of the `\up` orientation of `A2`, the centering is the same as in the vertical direction.

A vertical connection is needed to connect the amperemeter with R_1 . This may be done by

```
\frompin A2b
\vtopin R11
```

which draw a wire down to the horizontal wire, starting at `A2b`. Instead of the second line `\vtopin npn1B` would do the same job because the horizontal position is irrelevant for `\vtopin`.

To connect the two amperemeters the drawing position is set to `A1t`, from where a wire is drawn upwards and a junction point is marked at that point by using

```
\frompin A1t
\ - 1 u
\ .1
```

The commands for connecting the second amperemeter are:

```
\frompin A2t
\vtopin .1
\htopin .1
```

The combination of `\htopin` and `\vtopin` is very useful to connect two points with an edge of wire. The driving voltage is typeset by

```
\ - 1 u
\cc\connection1 {$U_b$} c u
```

because it looks better to put the inscription of the voltage on the right. That is why the prefix `\cc` is used in front of the `\connection` command.

Finally the emitter contact leads to the ground:

```

\frompin npn1E
\ - 1 d
\GND1

```

The whole example once more in an overview:

```

\begin{circuit}0
\npn1 {?} B 1          % transistor
\frompin npn1C        % draw from collector
\ - 1 u                % some wire
\nl\A1 {\$I_C\$} u    % amperemeter for current of collector
\atpin npn1B          % continue drawing from base
\ - 1 l                % some wire
\R1 {510\kohm} 1      % resistor
\ - 1 l                % some wire to the edge
\centerto A1          % draw centered to amperemeter 1
\nl\A2 {\$I_B\$} u    % amperemeter 2
\frompin A2b          % link amperemeter 2 with resistor
\vtopin R1l           %
\frompin A1t          %
\ - 1 u                %
\ .1                   % junction
\frompin A2t          % wire to amperemeter 2
\vtopin .1            %
\htopin .1            %
\ - 1 u                %
\cc\connection1 {\$U_b\$} c u % driving voltage
\frompin npn1E        %
\ - 1 d                %
\GND1                  % ground
\end{circuit}

```

6 Optics

If the `optics` option is given in the `\usepackage` command, the creation of simple optical diagrams is possible.

The optical axis can be drawn with the `\oa` command, which creates a dashed line. The optical symbols which are available are listed at the end of the appendix.

Here is an example for using `optics`. With the knowledge of drawing circuits the following code will speak for itself.

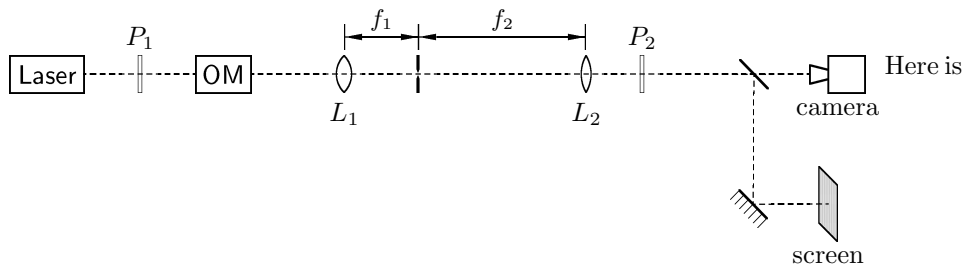

the code:

```

\begin{circuit}{0}
  \nl\Laser1 {} r           % laser
  \oa 2 r                   % optical axis
  \Polar1 {} r              % polarizer
  \oa 2 r
  \nl\OM1 P1 {} {} {} {} h % optical modulator
  \atpin OM1P3
  \oa 4 r
  \cc\BLens1 {} r          % 1st lens
  \oa 2 r
  \nl\Pinhole1 {} r       % pinhole
  \oa 7 r
  \cc\SLens2 {} r         % 2nd lens
  \oa 1 r
  \Polar2 {} r            % analyzer
  \oa 3 r
  \oa 3 r
  \nl\BSplit1 {} + d      % beam splitter
  \atpin BSplit1+        % continue drawing right
  \oa 2 r
  \nl\Cam1 {camera} . r   % camera
  \atpin BLens1: \shift 0 2 \P3 % mark middle of 1st lens
  \atpin Pinhole1: \shift 0 2 \P4 % mark middle of pinhole
  \atpin SLens2: \shift 0 2 \P5 % mark middle of 2nd lens
  \Dtext{\small $f_1$} from P3 to P4 % f_1
  \Dtext{\small $f_2$} from P4 to P5 % f_2
  \atpin BSplit1.        % second part of beam down
  \oa 5 d
  \Mirror1 {} * R         % mirror
  \oa 2 r
  \nl\ScrL1 {screen} h    % white screen
\end{circuit}

```

7 Some hints for CIRC programmers

Here are some hints to add further symbols to CIRC.

Before creating any new symbol consult very carefully the file `csym.mf`. It contains a lot of very useful definitions to simplify writing new symbols. Examples for the use of these definitions are given in the files `ciwidko.mf` and `optic.mf`. When possible it is strongly recommended to use the METAFONT commands

`twochars` for symbols with the symmetry two,
`fourchars` for symmetry four and
`fourfourchars` for symmetry eight,

because the definition of the corresponding T_EX command will need only one line! If there are any problems with METAFONT do not hesitate to contact the authors.

A new option file with the extension `def`, for instance `newcirc.def`, has to be created to include the written symbols. To include the new definitions add `newcirc` to the options in the `\usepackage` command:

```
\usepackage[basic,newcirc]{circ} .
```

The CIRC-command `\freecirc` has to be used to start the definitions of new commands in the file `newcirc.def`. This ensures, that the asterix (`'*`) becomes active, because all internal CIRC commands contain the asterix. It is comparable to L^AT_EX's `\makeatletter`. The CIRC-command `\protectcirc` has to be used at the end of the file `newcirc.def` in order to restore the former behaviour (comparable to `\makeatother`).

The `\cdef*` commands are strongly recommended to declare commands with the new symbols, because only one line is needed for the definition. The files `basic.def` or `optics.def` contain examples for `\cdef` and related commands, which are defined in `circ.sty`.

To ensure that the new symbols are inserted in the right magnification the command `\extracircinit` may be used. It can be used in the same way as `\opticfontinit` is used in `optics.def`. Both are defined in `circ.sty` as `\relax` and are called when a new diagram is initialized. If it is necessary to do any operations before starting a circuit diagram, then it is possible to redefine `\extracircinit` to do the job.

8 Future plans

CIRC is still under development. A lot of users need additional symbols or have other wishes. In most of the cases there is a quick solution, but to give CIRC the ability to be an easy extendable tool (and to add more potentiality) it has to be rewritten. Until this is done there could happen the following steps:

- solve the problem of inscriptions for transistors
- redesign some symbols and reimplement the METAFONT sources
- rewrite the font selection to fix some ugly effects
- add color support and build a METAPOST port
- use the NFSS2 to make different linethicknesses available
- describe the link between T_EX and META
- update the documentation every time

9 Contacting the authors

Any bug reports, remarks, proposals for new options and symbols, any improvements to both the code or the documentation as well as some nice postcards are welcome.

Sebastian Tannert
WEN 67.02.01.06
Harbigstraße 14
D-14055 Berlin

Andreas Tille
Gartenstraße 8
D-38855 Wernigerode

tannert@physik.hu-berlin.de







tille@physik.uni-halle.de

The symmetries and there parameters:

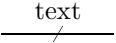

symmetrie	parameter set
<i>OP</i>	<i>number</i> \square
<i>LI</i>	<i>length</i> \square <i>direction</i> \square
<i>LB</i>	<i>number</i> \square <i>text</i> \square <i>direction</i> \square
<i>TXT</i>	<i>text</i> \square <i>from</i> \square <i>pin_reference1</i> \square <i>to</i> \square <i>pin_reference2</i> \square
<i>SO</i>	<i>number</i> \square <i>text</i> \square <i>direction</i> [l,r,u,d] \square
<i>SX</i>	<i>number</i> \square <i>text</i> \square <i>direction</i> [l,r,u,d,L,R,U,D] \square
<i>SXY</i>	<i>number</i> \square <i>text</i> \square <i>direction</i> [l,r,u,d] \square
<i>S3P</i>	<i>number</i> \square <i>text</i> \square <i>pin_name</i> \square <i>direction</i> [l,r,u,d,L,R,U,D] \square
<i>GI</i>	<i>number</i> \square <i>text</i> \square <i>pin_name</i> \square <i>label a</i> \square <i>label b</i> \square
<i>GII</i>	<i>number</i> \square <i>text</i> \square <i>pin_name</i> \square <i>label a</i> \square <i>label b</i> \square <i>label c</i> \square
<i>BX</i>	<i>number</i> \square <i>pin_name</i> \square <i>label a</i> \square <i>label b</i> \square <i>label c</i> \square <i>label d</i> \square
<i>BXT</i>	<i>number</i> \square <i>text</i> \square <i>pin_name</i> \square <i>label a</i> \square <i>label b</i> \square <i>label c</i> \square <i>label d</i> \square
<i>IC</i>	<i>number</i> \square <i>text</i> \square <i>pin_name</i> \square <i>style</i> ² \square













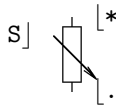
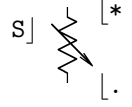

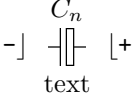
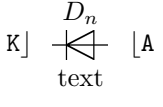
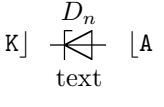
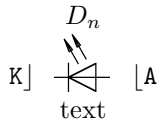
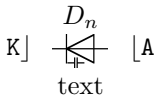
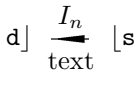
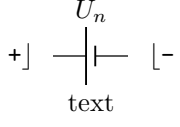
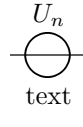
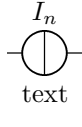
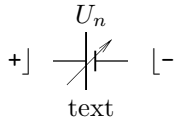
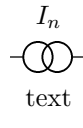
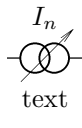
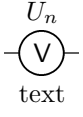
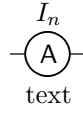

`\CIRCLogo`

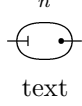
wire 	dashed wire 	bundle 
<code>\wire</code> <i>LI</i>	<code>\dashed</code> <i>LI</i>	<code>\bundle</code> <i>LB</i>
double wire 	text with arrow 	centered text 
<code>\wwire</code> <i>LB</i>	<code>\Utext</code> <i>TXT</i>	<code>\centertext</code> <i>TXT</i>

Symbols provided by the option `basic.def`

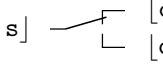
ground 	ground 	junction 
<code>\GND</code> <i>OP</i>	<code>\gnd</code> <i>OP</i>	<code>\.</code> <i>OP</i>

resistor  $\backslash R$ $S\mathcal{X}\mathcal{Y}$	US resistor  $\backslash Rus$ $S\mathcal{X}\mathcal{Y}$	variable resistor  $\backslash Rvar$ $S3\mathcal{P}$
variable resistor  $\backslash Rusvar$ $S3\mathcal{P}$	capacitor  $\backslash C$ $S\mathcal{X}\mathcal{Y}$	variable capacitor  $\backslash Cvar$ $S\mathcal{X}\mathcal{Y}$
electrolytic capacitor  $\backslash Cel$ $S\mathcal{X}$	diode  $\backslash D$ $S\mathcal{X}$	Zener diode  $\backslash ZD$ $S\mathcal{X}$
light emitting diode  $\backslash LED$ $S0$	capacitance variation diode  $\backslash Dcap$ $S\mathcal{X}$	current flow  $\backslash whatI$ $S\mathcal{X}$
voltage source  $\backslash U$ $S\mathcal{X}$	voltage source, variant  $\backslash varU$ $S\mathcal{X}\mathcal{Y}$	current source variant  $\backslash varI$ $S\mathcal{X}\mathcal{Y}$
variable voltage source  $\backslash Uvar$ $S\mathcal{X}$	current source  $\backslash I$ $S\mathcal{X}\mathcal{Y}$	variable current source  $\backslash Ivar$ $S\mathcal{X}\mathcal{Y}$
voltmeter  $\backslash V$ $S\mathcal{X}\mathcal{Y}$	amperemeter  $\backslash A$ $S\mathcal{X}\mathcal{Y}$	coil  $\backslash L$ $S\mathcal{X}$
quartz crystal  $\backslash xtal$ $S\mathcal{X}\mathcal{Y}$	incandescent lamp  $\backslash La$ $S\mathcal{X}\mathcal{Y}$	gas lamp  $\backslash GasLa$ $S\mathcal{X}\mathcal{Y}$

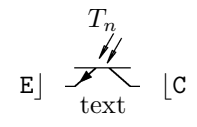
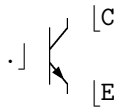
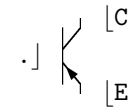
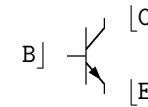
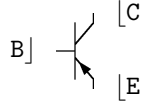
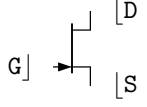
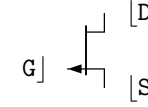
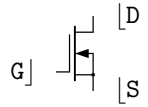
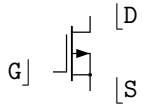
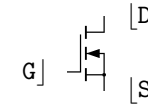
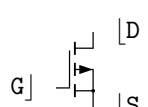
switch  S_n text	changeover switch  s] [c [o	connection (pointed)  [c text
$\backslash S$ $S\mathcal{X}\mathcal{Y}$	$\backslash SW$ $S3\mathcal{P}$	$\backslash mconnection$ $S\mathcal{X}$
connection (round empty)  [c text	connection (round full)  [c text	phototransistor  T_n E] [C text
$\backslash connection$ $S\mathcal{X}$	$\backslash fconnection$ $S\mathcal{X}$	$\backslash npnPH$ $S\mathcal{O}$
npn-transistor without base  [C [E	pnp-transistor without base  [C [E	npn-transistor  B] [C [E
$\backslash npnEC$ $S3\mathcal{P}$	$\backslash pnpEC$ $S3\mathcal{P}$	$\backslash npn$ $S3\mathcal{P}$
pnp-transistor  B] [C [E	n-channel field effect transistor  G] [D [S	p-channel field effect transistor  G] [D [S
$\backslash pnp$ $S3\mathcal{P}$	$\backslash nfet$ $S3\mathcal{P}$	$\backslash pfet$ $S3\mathcal{P}$
 G] [D [S	 G] [D [S	 G] [D [S
$\backslash nvmos$ $S3\mathcal{P}$	$\backslash pvmos$ $S3\mathcal{P}$	$\backslash namos$ $S3\mathcal{P}$
 G] [D [S		
$\backslash pamos$ $S3\mathcal{P}$		

Symbols provided by the option `gate.def`

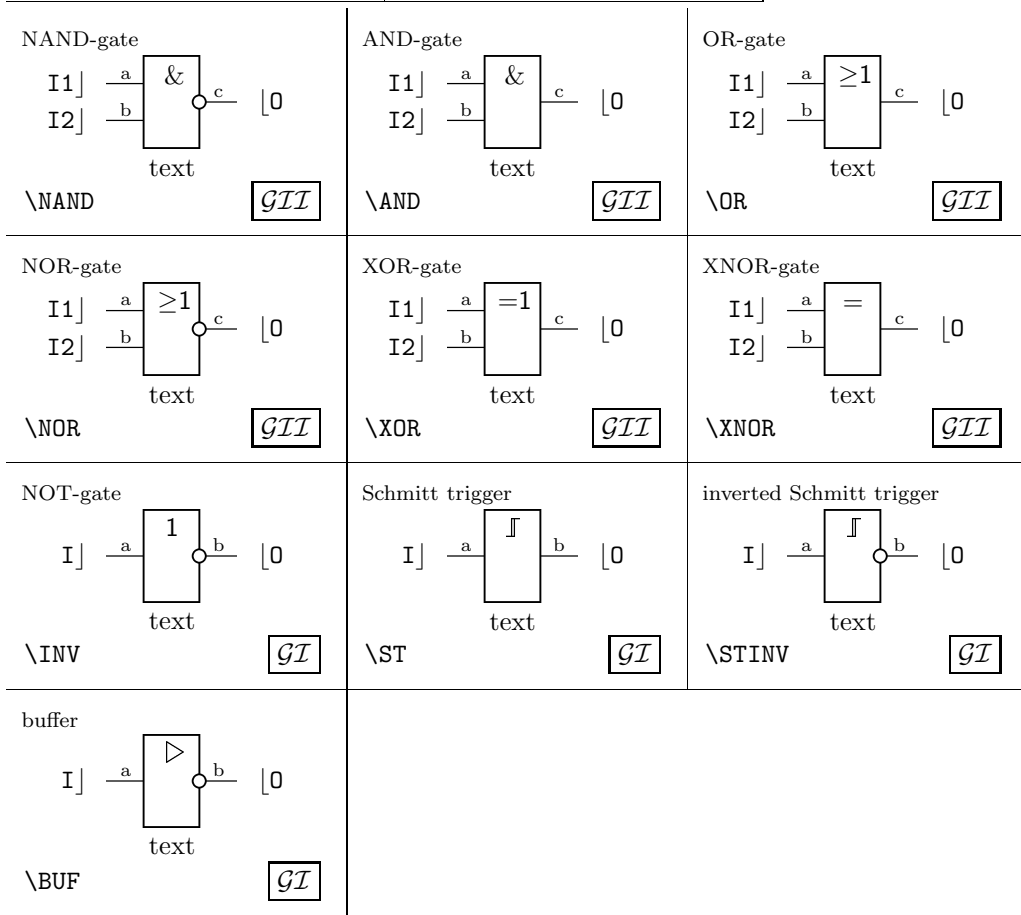
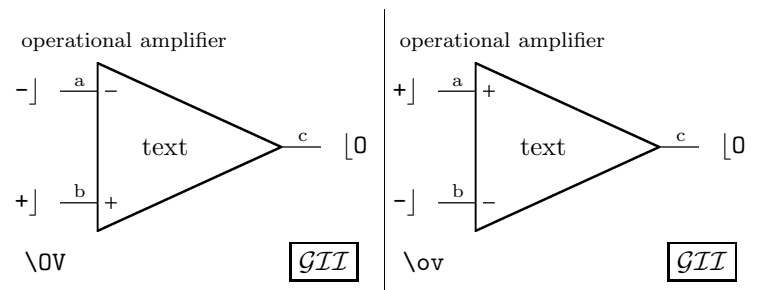

Symbols provided by the option `oldgate.def`

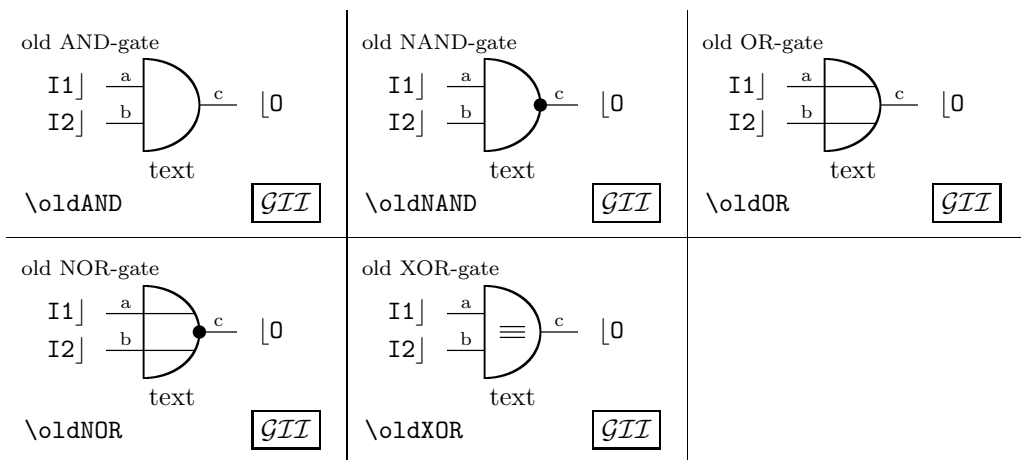

Symbols provided by the option `box.def`

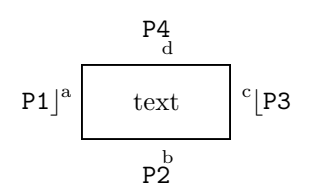
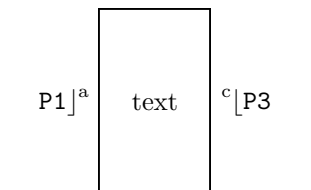
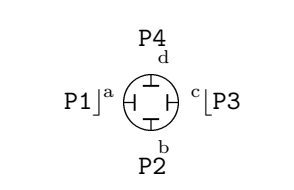
<p>black box analog</p>  <p>$P1]^a$ $P2]^b$ $P3]^c$ $P4]^d$</p> <p>\BBa $\mathcal{B}\mathcal{X}\mathcal{T}$</p>	<p>black box digital</p>  <p>$P1]^a$ $P2]^b$ $P3]^c$ $P4]^d$</p> <p>\BBd $\mathcal{B}\mathcal{X}\mathcal{T}$</p>	<p>oscilloscope</p>  <p>$P1]^a$ $P2]^b$ $P3]^c$ $P4]^d$</p> <p>\oscollograph $\mathcal{B}\mathcal{X}$</p>
--	---	---











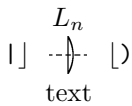

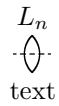

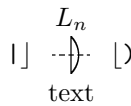

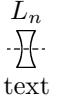

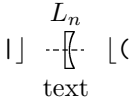

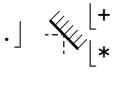

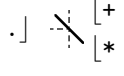





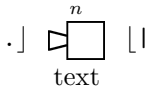

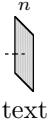

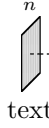

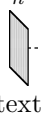

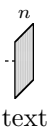
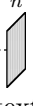
<p>generator</p> <p>$\backslash G$ \mathcal{BX}</p>	<p>generator, variable</p> <p>$\backslash Gvar$ \mathcal{BX}</p>	<p>generator, pulses</p> <p>$\backslash Impulse$ \mathcal{BX}</p>
<p>amplifier</p> <p>$\backslash Amp$ \mathcal{BX}</p>	<p>AC to DC converter</p> <p>$\backslash ACtoDC$ \mathcal{BX}</p>	

Symbols provided by the option `ic.def`





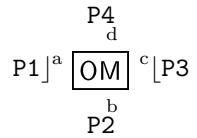





<p>RS flip flop</p> <p>$\backslash RSFF$ \mathcal{IC}</p>	<p>RS flip flop</p> <p>$\backslash NRSFF$ \mathcal{IC}</p>	<p>D flip flop</p> <p>$\backslash DFF$ \mathcal{IC}</p>
<p>JK master slave flip flop</p> <p>$\backslash JKMSFF$ \mathcal{IC}</p>	<p>timer NE555</p> <p>$\backslash fff$ \mathcal{IC}</p>	<p>nullor</p> <p>$\backslash NULL$ \mathcal{IC}</p>

Symbols provided by the option `optics.def`

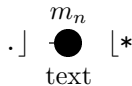
<p>text measuring a length</p> <p>$\backslash Dtext$ \mathcal{TXT}</p>	<p>optical axis</p> <p>$\backslash oa$ \mathcal{LI}</p>	<p>thin lens</p> <p>$\backslash SLens$ \mathcal{SXY}</p>
--	---	--

<p>half thin lens</p>  <p>L_n] ] text</p> <p><code>\HSLens</code> $\boxed{S\mathcal{X}}$</p>	<p>thick lens</p>  <p>L_n] ] text</p> <p><code>\BLens</code> $\boxed{S\mathcal{X}\mathcal{Y}}$</p>	<p>half thick lens</p>  <p>L_n] ] text</p> <p><code>\HBLens</code> $\boxed{S\mathcal{X}}$</p>
<p>concave lens</p>  <p>L_n] ] text</p> <p><code>\VLens</code> $\boxed{S\mathcal{X}\mathcal{Y}}$</p>	<p>half concave lens</p>  <p>L_n] ] text</p> <p><code>\HVLens</code> $\boxed{S\mathcal{X}}$</p>	<p>mirror</p>  <p>] ] text</p> <p><code>\Mirror</code> $\boxed{S3\mathcal{P}}$</p>
<p>beam splitter</p>  <p>] ] text</p> <p><code>\BSplit</code> $\boxed{S3\mathcal{P}}$</p>	<p>polarizer</p>  <p>P_n] ] text</p> <p><code>\Polar</code> $\boxed{S\mathcal{X}\mathcal{Y}}$</p>	<p>pinhole</p>  <p>] ] text</p> <p><code>\Pinhole</code> $\boxed{S\mathcal{X}\mathcal{Y}}$</p>
<p>camera</p>  <p>] ] text</p> <p><code>\Cam</code> $\boxed{S\mathcal{X}}$</p>	<p>screen, look at the left side</p>  <p>] ] text</p> <p><code>\ScrL</code> $\boxed{S\mathcal{X}\mathcal{Y}}$</p>	<p>screen, look at the right side</p>  <p>] ] text</p> <p><code>\ScrR</code> $\boxed{S\mathcal{X}\mathcal{Y}}$</p>
<p>screen, look behind the left side</p>  <p>] ] text</p> <p><code>\ScrBL</code> $\boxed{S\mathcal{X}\mathcal{Y}}$</p>	<p>screen, look behind the right side</p>  <p>] ] text</p> <p><code>\ScrBR</code> $\boxed{S\mathcal{X}\mathcal{Y}}$</p>	<p>screen, look trough the left side</p>  <p>] ] text</p> <p><code>\ScrTL</code> $\boxed{S\mathcal{X}\mathcal{Y}}$</p>
<p>screen, look trough the right side</p>  <p>] ] text</p> <p><code>\ScrTR</code> $\boxed{S\mathcal{X}\mathcal{Y}}$</p>	<p>laser</p>  <p>] ] text</p> <p><code>\Laser</code> $\boxed{S\mathcal{X}\mathcal{Y}}$</p>	<p>photometer, -multiplier, etc.</p>  <p>] ] text</p> <p><code>\PM</code> $\boxed{S\mathcal{X}\mathcal{Y}}$</p>
<p>optical modulator</p>  <p>$P1]^{a}$  $]^{c}P3$ $P2]^{b}$ text</p> <p><code>\OM</code> $\boxed{B\mathcal{X}}$</p>		

Symbols provided by the option $\boxed{\text{physics.def}}$

spring  k_n text <code>\spring</code> $\boxed{S\mathcal{Y}}$	long spring  k_n text <code>\lspring</code> $\boxed{S\mathcal{Y}}$
mass with two forces; full drawn  m_n text <code>\fdmass</code> $\boxed{S\mathcal{Y}}$	mass with two forces; outlined  m_n text <code>\dmass</code> $\boxed{S\mathcal{Y}}$
mass; full drawn  m_n text <code>\fmass</code> $\boxed{S\mathcal{X}}$	mass; outlined  m_n text <code>\mass</code> $\boxed{S\mathcal{X}}$
wall  text <code>\wall</code> $\boxed{S\mathcal{X}}$	tile  text <code>\tile</code> $\boxed{S\mathcal{X}}$
spin up  S_n text <code>\spinu</code> $\boxed{S\mathcal{Y}}$	spin down  S_n text <code>\spind</code> $\boxed{S\mathcal{Y}}$

THE CODE OF CIRC.

```
1 <*code>
2 \NeedsTeXFormat{LaTeX2e}[1995/12/01]
3 \ProvidesClass{circ}
4   [1997/04/23 v1.0d for typeset circuit diagrams]
5 \DeclareOption*{\InputIfFileExists{\CurrentOption.def}{}%
6   {\PackageError{CIRC}{File \CurrentOption.def not found.}%
7     {Check spelling or think about the
8       location of file.\MessageBreak
9       I tried to load macros for the CIRC package.}}}
```

Sorry, but it's better to stop here. The sourcecode is formatted worst.